

# **Use of an Artificial Neural Network as a Model for Human Behavior: A Proposed Framework for Investigation of the Question of Free Will**

**Lindell Ormsbee  
Kentucky Water Resources Research Institute  
University of Kentucky  
lormsbee@engr.uky.edu**

## **1. Introduction**

The field of mathematics is replete with examples of overtly complex problems that can be simplified through the addition of another variable or parameter (e.g. a constrained optimization problem can be reduced to an unconstrained problem through the addition of a Lagrange multiplier.) In this paper, I will use concepts from the field of artificial intelligence and, in particular, artificial neural networks to propose a mathematical model that may provide some insight into the fundamental question about the nature of free will and its role in the response of free creatures. The goal of this paper is that by introducing additional mathematical perspectives into an overtly complex philosophical problem, I might generate some new insights in facilitating progress toward a potential resolution of this issue.

On a more personal level, I was motivated to write this paper out of a desire to formulate analogies for use in communicating Christian theological perspectives with many of my Muslim graduate students. I have found that a common understanding of the principles of mathematical modeling (and in particular neural network models) along with a deep appreciation for the sovereignty of God has provided an effective springboard for both theological and evangelical discussions with such students.

## **2. A Conceptual Model of Human Behavior**

The use of conceptual models or analogies to describe human behavior is not new. One of the more widely known models is Berne's<sup>1</sup> Parent-Adult-Child model. While no one would claim that the human personality is literally composed of three distinct physical or even psychological units, the PAC model nonetheless has proven useful for a better understanding of human nature and for analyzing the transactions between individuals. Indeed, despite the potential pitfall of modalism, I have found the PAC model a useful analogy for explaining the concept of the Trinity to students of both Muslim and Mormon faiths.

A commonly used maxim of mathematical modeling states, "Essentially, all models are wrong, but some are useful".<sup>2</sup> Thus, in the current work, my goal is not to propose a completely comprehensive nor totally accurate mathematical model of human behavior (which of course would presuppose that a consensus model actually exists), but

to rather propose a model of human behavior that can serve as a useful framework for a subsequent examination of the question of free will.

For the purposes of this study, I propose human behavior to be composed of three basic components: 1) the mind, 2) the heart, and 3) the will. Thus, I conceptualize any human behavior or action to be in response to either an internal or external cause that is then operated on by the mind, the heart, and the will in that order (e.g. Romans 6:17). While the latter two components may be assumed to be subcomponents of the mind, I will treat each as distinct elements as shown in Figure 1. I readily acknowledge that such a model is overly simplistic and ignores the explicit influences of other potential components such as perceptions, beliefs, memories, conscience, knowledge, emotions, feelings, etc. However, for the purposes of our discussion, I acknowledge that these additional elements exist, but I will assume they are incorporated within the broader context of the mind or soul.

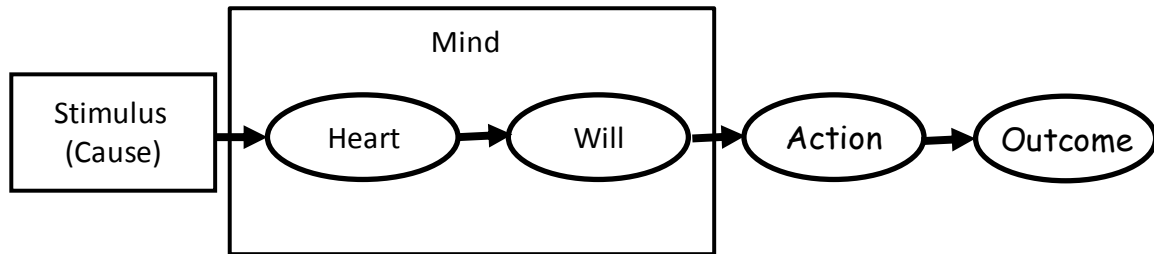

**Figure 1. Simplified Conceptual Model for Human Behavior**

In the proposed model, the primary focus will be on the heart (as a psychological or theological term) and will subcomponents, and the role that they play in human response, especially in the context of soteriology. In proposing such a model, I recognize that there is a lack of consensus among theologians with regard to the meaning and scope of the term “heart.” Indeed, in the Bible the term “heart” is frequently used as a synonym for the mind, the emotions, and the will. For the purposes of this model, the word “heart” will be defined as that part of the human mind or soul from which desires originate. In contrast, the word “will” is defined as that part of the human mind or soul from which a choice is made.

By selecting the heart and the will as the primary elements of the proposed model, I intend to reflect the domain of the debate with regard to the nature of free will. Those who hold for a libertarian view of free will normally argue that our wills have the capacity to act independent or even contrary to the desires of the heart, while those who would hold for a compatibilist view of free will normally argue that our wills function as agents of our hearts.<sup>3</sup> Thus, when commenting on Luke 6:43-45, Bruce Ware states, “Probably the single most important biblical conception relating to the question of human freedom is the notion that we human beings perform our choices and actions out of what we desire in our hearts. That is, what we want most, what our natures incline us most strongly to – this is the pool out of which the stream of our choices and actions flows.”<sup>4</sup> Conversely, when commenting on Romans 7:15, Norman Geisler argues that “personal

experience reveals that we sometimes act contrary to our strongest desires, such as to retaliate or to shirk responsibility.”<sup>5</sup>

With these definitions and perspectives in place as a backdrop, I will now attempt to use this model of the human soul to illustrate several different perspectives on the nature of free will. In subsequent visualizations, I will drop the outer box representing the mind (see Figure 1) for simplicity, while still acknowledging its presence and influence. I will then expand this model further by incorporating concepts from artificial neural network theory.

### **3. The Nature of God’s Knowledge**

One might argue that a proper understanding of the nature of man’s free will is directly tied to the nature of his creator and, in particular, the types of knowledge that such a creator possesses. Traditionally, theologians have ascribed to God three different types of knowledge.<sup>6</sup> I will summarize each type as follows:

#### ***Natural Knowledge***

Natural (or independent) knowledge is God’s knowledge of all contingencies - i.e. God’s knowledge of everything that *could* happen. Biblical support for the existence of natural knowledge can be found in Psalm 139:2-4, Job 37:16, and I John 3:20.

#### ***Free Knowledge***

Free (or dependent) knowledge is God’s knowledge of all necessities – i.e. God’s knowledge of everything that *will* happen following his decision to act in a certain way. Biblical support for the existence of free knowledge can be in found in passages such as Matthew 20:17-19 and Acts 17:26.

#### ***Middle Knowledge***

Middle knowledge is God’s knowledge of all true “counterfactuals of creaturely freedom” – i.e. God’s knowledge of everything that *would* happen in response to a particular set of circumstances. Biblical support for the existence of God’s middle knowledge is found in passages such as Exodus 13:17, I Samuel 23:9-12, Jeremiah 23:21-22, Matthew 11:21-24, and I Corinthians 2:8. Middle knowledge is not free knowledge, because the knowledge is independent or prior to God’s decision to act. Likewise, middle knowledge is not natural knowledge, because it is dependent or contingent upon the actions of free agents.

### **4. The Nature of Humankind’s Freedom**

Given a conceptual model of humankind’s behavior and a brief review of the nature of God’s knowledge, we are now in a position to visualize the two different views of freedom that theologians usually employ to explain or defend the traditional orthodox

positions of Christian soteriology (i.e. Arminianism or Calvinism). Each position is based on different definitions of human freedom, namely indeterminism (or libertarian free will) and soft determinism (or compatibilist free will).

***Indeterminism, or Libertarian Free Will***

Here, I define indeterminism, or libertarian free will, as a situation in which no “upstream” influence (i.e. circumstance, desire, etc.) can decisively incline the will to choose one action versus another. I illustrate this concept in Figure 2 by using the dashed lines to signify the lack of any decisively controlling influence “upstream” of the will. In fact, in this case, one might define free will as the ability for the will to act contrary to the strongest inclinations of the heart. I must emphasize that this definition does not say that such actions lack causes and conditions altogether, only that free actions have no sufficient causes.<sup>7</sup> Examples of scriptures that have been used in support of a libertarian view of free will include Genesis 2:16-17, Joshua 24:15, and Matthew 23:37. From a traditional Arminian position, God’s election is based on the use of his natural knowledge by virtue of him being able to look forward into time and see the future acts of libertarian free agents.

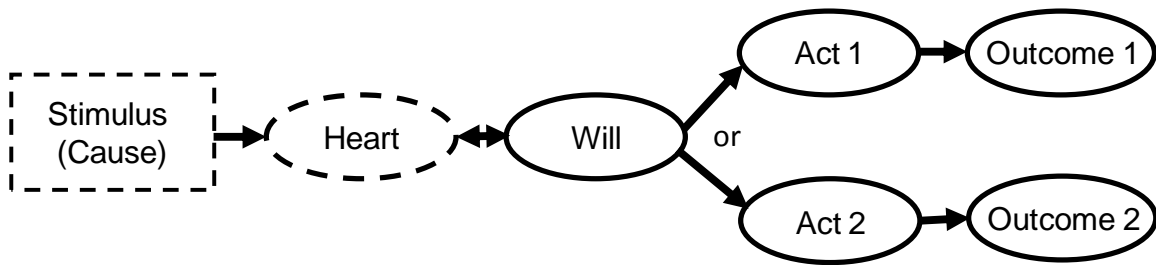

**Figure 2. Illustration of Indeterminism (Libertarian Free Will)**

An alternative Arminian, or open theism, position would hold that God’s election is of the church as a corporate body and not of that of an individual. Thus, “when a person chooses to be incorporated into this group by believing in Jesus, all that is predestined for the group now applies to that person.”<sup>8</sup> In this case, God’s election is based on his free knowledge.

***Soft Determinism, or Compatibilist Free Will***

Here, I define soft determinism as a situation in which the desires of the heart decisively incline the will in one direction or the other. In this case, free will is the ability or freedom of the will to act consistently with the strongest inclinations or desires of the heart. This is illustrated in Figure 3. Examples of scriptures that have been used in support of a compatibilist view of free will include Luke 6:43-45 and Romans 7:15-20. From a traditional Calvinist position, God’s election is based on the use of his free

knowledge by virtue of his changing or regenerating the heart to decisively incline it to respond favorably to the gospel (i.e. stimulus or cause). Once decisively inclined, the will then follows suit.

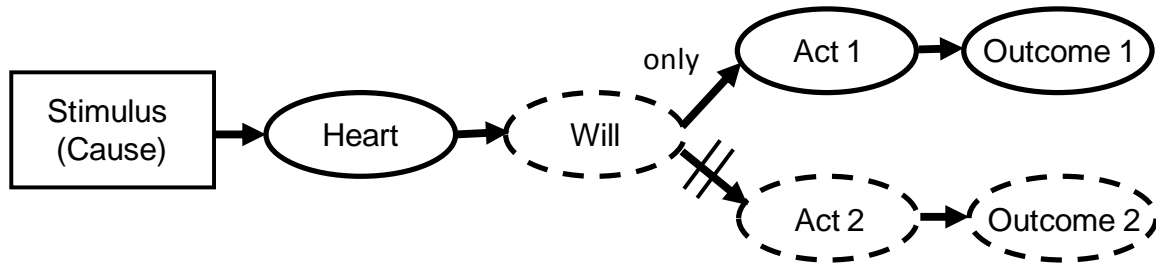

**Figure 3. An Illustration of Soft Determinism (Compatibilist Free Will)**

***The Middle Knowledge Position***

Attempts to reconcile the Calvinist and Arminian positions have been largely unsuccessful, although the Jesuit Molina did propose an intriguing hypothesis that relies on the use of middle knowledge.<sup>9</sup> While Molina predicated his original proposal on a use of a libertarian free will, later scholars have also adapted middle knowledge for use with a compatibilist view of free will.<sup>10</sup>

The implications of middle knowledge for libertarian free will can perhaps best be explained through an illustration.<sup>11</sup> For the purposes of this example, I will assume that, prior to creation, God has an infinite number of possible worlds that he may create (see Figure 4a). God’s derives his knowledge of what could happen in each of these worlds from his natural knowledge of all possible contingencies. Based on God’s middle knowledge—that is, his knowledge of all contingent counterfactual propositions—he may decide to eliminate some of the possible worlds from consideration, thereby leaving a smaller set of feasible worlds from which to actualize (see Figure 4b). Based on God’s middle knowledge, God knows what will happen in each of these remaining feasible worlds if God so chooses to create one. Thus, I may hypothesize the existence of a created Being A that is placed in world #1 as well as world #2. On the basis of God’s middle knowledge, God knows that if Being A is placed in world #1 he or she will behave in one way (e.g. accept Christ as savior – i.e. A), while if he or she is placed in world #2 then he or she will behave in another way (e.g. reject Christ as savior – i.e. A’). For our example problem, let us assume that God chooses to create world #1. Then on the basis of his middle knowledge, God then knows with absolute certainty that in creating world #1 he is predestining Being A to salvation without violating his or her libertarian free will. As summarized by William L. Craig, “in Molina’s view, we might say that it is up to God whether we find ourselves in a world in which we are predestined, but it is up to us whether we are predestined in the world we find ourselves.”<sup>11</sup>

a. Range of Possible Worlds (Things that could happen)



b. Range of Feasible Worlds (Things that would happen)



c. God's Decision to Create a World (Things that will happen)

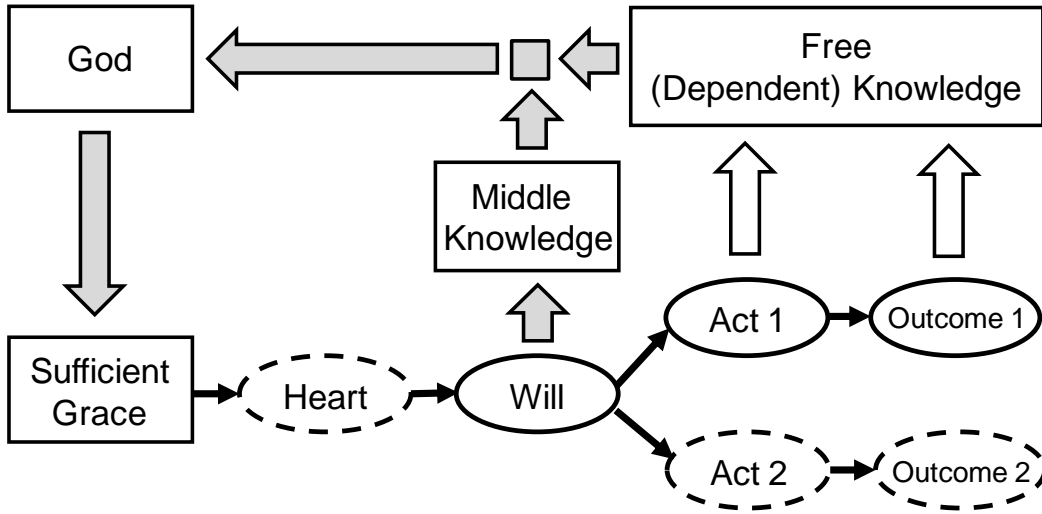

**Figure 4. The Range of Possible Worlds<sup>12</sup>**

In order to avoid a Pelagian option in the previous example, I will assume that God gives sufficient or prevenient grace to everyone in the created world, thus enabling each person to use his or her libertarian free will to respond to the gospel. However, on the basis of God's middle knowledge, he knows that A will respond positively to such graces while A' will not. In this case, God's prevenient grace now becomes efficacious for A while it remains merely sufficient for A'. The efficacy of the grace, however, is not found in the gospel call itself (as in Calvinism), but flows from God's exercise of his free knowledge conditioned on his middle knowledge (see Figure 5). This position is obviously different from traditional Arminianism, which relies on natural knowledge as the basis of God's election of the individual; it also differs from open theism, which relies on free knowledge as the basis of God's election of the corporate church.

If one temporarily sets aside the more recent arguments of the open theists<sup>13,14,15,16</sup> and argues that God does in fact know the future actions of free agents, a debate remains about whether or not such knowledge is attainable assuming a libertarian free will, even if middle knowledge is employed. Open theists such as Clark Pinnock seem unconvinced<sup>17</sup>. At the other end of the theological perspective, Bruce Ware has argued that while middle knowledge does in fact exist, the only free will that can be known from its use is that of a compatibilist free will. Thus Ware uses middle knowledge in support of Calvinism.<sup>18</sup> Such a formulation is in fact, very similar to Congruism as first proposed by Suarez.<sup>19</sup> However, in Ware's case, at least sequentially, it is the desires of the heart and not the will that are accessible through middle knowledge (although technically the actions of the will are directly known from the desires of the heart). In this case, God decides to elect A. Thus, at this point, the election of A is predicated on God's use of his free knowledge. Then, on the basis of God's middle knowledge of A's compatibilist free will, God chooses to employ an effectual grace to which he knows A will positively respond. In this case, one may argue that the efficacy of the grace is found in its effectual nature and flows from God's exercise of his middle knowledge conditioned on his free knowledge. Those not given such effectual graces remain lost. This position is illustrated

in Figure 6 and is different from traditional Calvinism, which relies exclusively on God’s free knowledge.



**Figure 5. Illustration of the “Middle” Arminian Position**

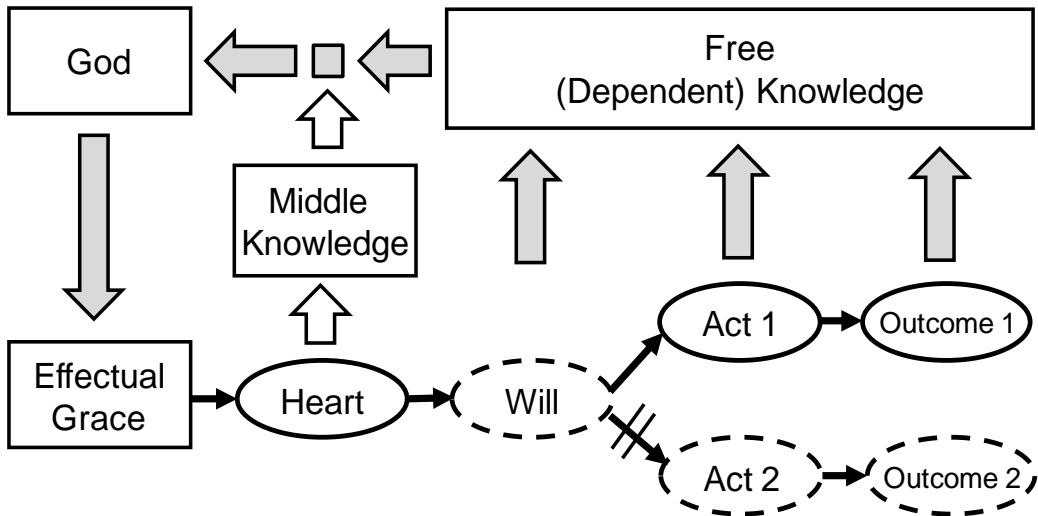

**Figure 6. Illustration of the “Middle” Calvinist Position**

This brief introduction illustrates the diversity of traditional perspectives on the nature of humankind’s freedom and how God acts in the context of that freedom. While this debate will not be resolved here, I hope that by recasting this philosophical and theological problem into a mathematical framework, I might provide some additional room for further exploration and discussion.

## 5. A Brief Overview of Artificial Neural Networks

An artificial neural network (ANN) is a mathematical model constructed to approximate the basic functions associated with a biological neuron (see Figure 7). In the

case of a biological neuron, the dendrites of the cell receive electro-chemical signals from other cells, which are then passed “downstream” through an associated axon. In a similar fashion, we can envision an artificial neural network as an interconnected network of neurodes or nodes (see Figure 8). In most cases, the network will be composed of an input layer of nodes, a middle or hidden layer of nodes, and an output layer (with one or more nodes). Numerical signals ( $X$ ) are then passed from node to node through a network of links or paths that form the network<sup>20,21</sup>. For notational purposes, I will assign the letter  $I$  to denote the particular node (or row) in the upstream layer (or column), the letter  $J$  to denote the particular node (or row) in the downstream layer (or column), and the letter  $K$  to denote the particular layer of nodes (column) of the upstream layer.

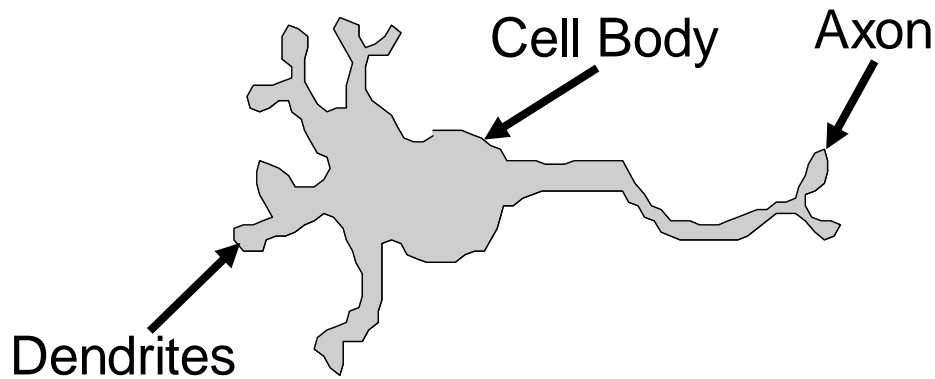

**Figure 7. A Biological Neuron**

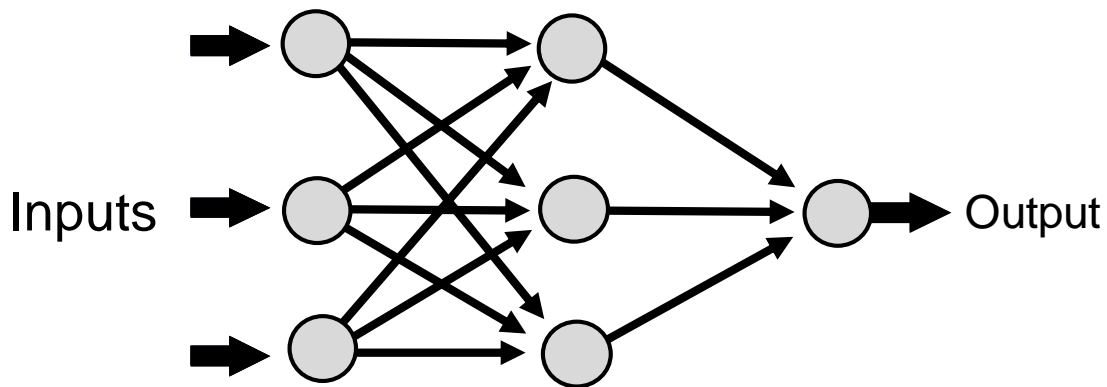
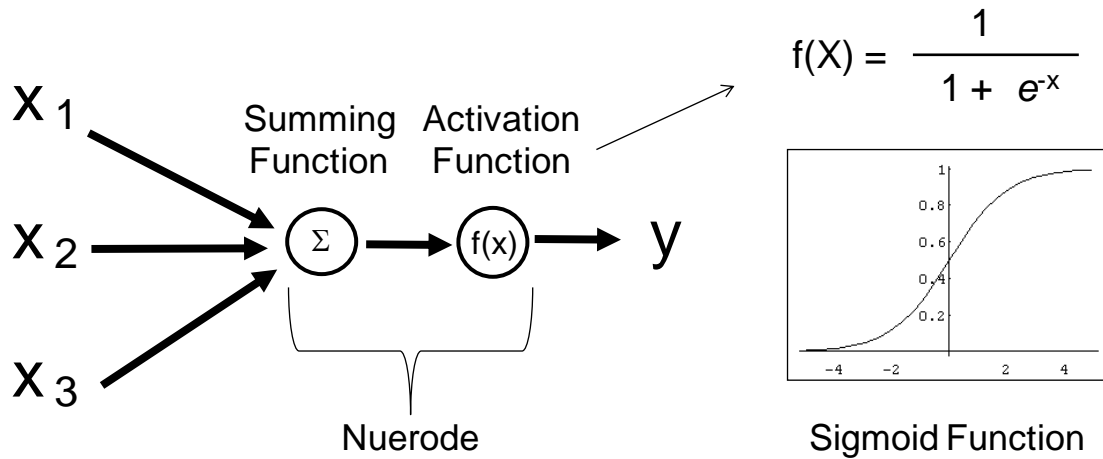

**Figure 8. The Typical Structure of an Artificial Neural Network**

Each node in the network acts as a composite function that transforms the input signal into an associated output signal through the use of one or more functions. Each node in the input layer is typically composed of a signal normalizing function that is used to transform the values of the input signal into a range of values between 0 and 1. Each node in the middle or hidden layer is typically composed of two functions: a summation function and an activation function (see Figure 9). The summation function simply sums the values associated with all upstream links or paths for a particular node. The activation function then transforms this value into a value between 0 and 1 through the use of a



mathematical equation. The most commonly used equation is a sigmoid function as illustrated in Figure 9 where  $e$  represents the base of the natural logarithm and is approximately equal to 2.71828.

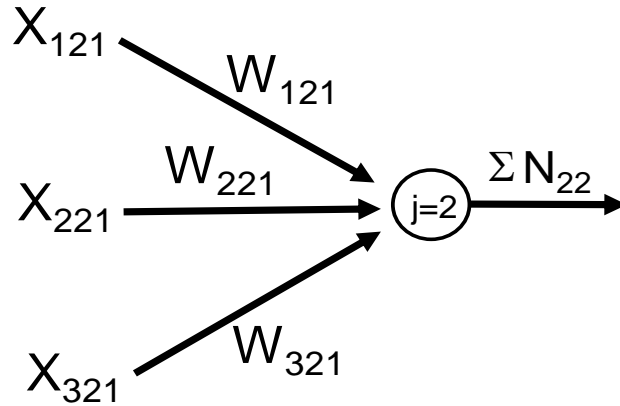

**Figure 9. Details of Neurone Transformation Function**

Once the network has processed the composite signal to the final output node or layer of nodes, the signal is once again aggregated and processed through a final activation function. Depending upon the range of the original output variable, one might map the final output value to this associated range. For example, in the case where the final output value is constrained by the activation function to a numerical value between 0 and 1, the value may need to then be mapped or converted to a different range (e.g. 0 and 100, 1 to 9, etc.).

A key feature of the neural network architecture is the use of weights that one assigns to each path or link in the network (see Figure 10). If the signal flowing from upstream layer  $K$  and node  $I$  to downstream node  $J$  can be expressed as  $X_{ijk}$ , then the associated weight for this signal can be assigned a value of  $W_{ijk}$ . Thus, for the case of three input nodes with output values of  $X_{121}$ ,  $X_{221}$ , and  $X_{321}$ , which are flowing downstream to node 2 in the middle layer, one can assign individual weights  $W_{121}$ ,  $W_{221}$ , and  $W_{321}$ . One then multiplies any output from an upstream node  $X_{ijk}$  by the corresponding weight  $W_{ijk}$  before summing the total with the other upstream weighted outputs to determine the total input to the downstream node. For example, for the case where the downstream node is in the middle or hidden layer (i.e.  $k=2$ ) and is the second node in that layer (i.e.  $j=2$ ), then the total may be expressed as  $\sum N_{jk}$  or  $\sum N_{22}$ , where:

$$\sum N_{22} = X_{121} * W_{121} + X_{221} * W_{221} + X_{321} * W_{321}$$



**Figure 10. Illustration of the Summation Operation**

One may now find the output  $Y_{jk}$  (see Figure 9) from node  $j=2$  and layer  $k=2$  by applying the sigmoid function as follows:

$$Y_{22} = 1/(1 + e^{-N_{22}})$$

This output now becomes the input signal for the downstream nodes that are receiving inputs from node  $N_{22}$ .

For a given set of inputs and outputs, one can now “train” or calibrate the ANN by iteratively adjusting the weights so that the ANN will produce an approximation of the observed output for a set of given inputs (see Figure 11). For example, if one were to collect several years of daily physical data from the past, say output data consisting of the maximum temperature from day  $n+1$  at location X and input data consisting of (1) the maximum temperature from day  $n$  at location X, (2) the maximum temperature from day  $n-1$  at location X, and (3) the maximum temperature data for day  $n$  at location Y, then one could construct a neural network with three input nodes corresponding to the three sets of input data and then train the network to predict the maximum temperature for location X for day  $n+1$ . As one obtains additional information, one can continually update the weights of the network as the network begins to “learn” about its environment. Once the ANN is trained, one can then use it to predict an output (e.g. maximum temperature for day  $n+1$  at location X) for a new independent set of inputs. In this way, one can adjust the ANN to respond to a new given stimulus based on what it has learned in the past. It is this feature of ANNs that one may conceptualize as an example of artificial intelligence or a situation where an ANN can be used to predict a human response or decision associated with a given set of stimuli or facts. The latter conceptualization will obviously be much more complex than the simple temperature example, but the general principle should hold. For example, by observing whether a person leaves to work each day with an umbrella based on inputs such as the daily weather forecast, the temperature, the day of the week, etc., one may be able to develop a neural network that could be used to predict that person's behavior. In this case, one could code the response as a binary response (i.e. yes or no), while in other problems one could use a continuous variable.

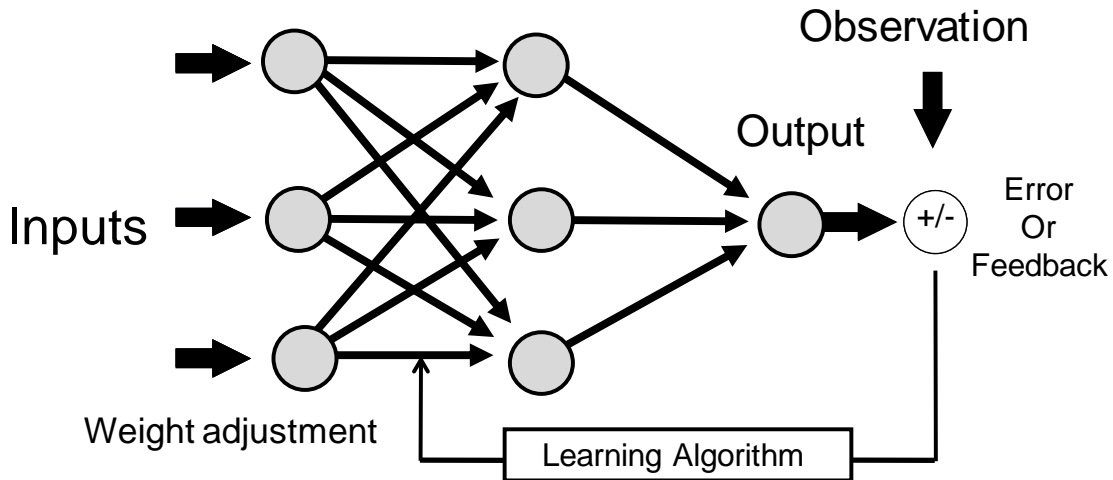

**Figure 11. Illustration of the Training Process of the ANN**

### 6. Conceptualization of Soft Determinism Using an ANN

Based on this brief introduction to artificial neural networks, I propose that such a model can be used to discuss the function of the human heart and the process whereby a dominant desire is synthesized from either an external or internal causative stimulus. Thus, relative to the soft determinism model of free will, I use the neural network to represent a conceptual model of the interaction between a causative input as well as any additional influence of the thoughts, beliefs, feelings, etc. of the soul as processed by the heart (see Figure 12). Thus, I use the output from the ANN to represent a dominant desire that then predisposes the will to act consistently in the fulfillment of such a desire.

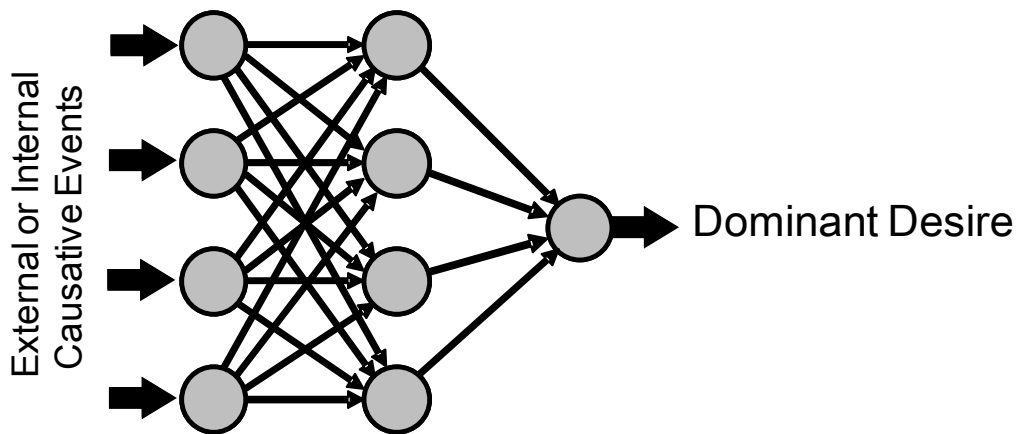

**Figure 12. Conceptualization of the Heart as an ANN**

### ***Conceptualization of the ANN as a Single Sigmoid Function***

In order to simplify the representation of the heart as an ANN, we can conceptualize the ANN itself as a single sigmoid function, whereby a vector of inputs  $\mathbf{X}$  can give rise to a single (scalar) desire  $Y$  as shown in Figure 13. In this case, the domain of the input vector  $\mathbf{X}$  represents the potentially infinite combinations of possible stimuli that may be experienced by an individual. The range of the output  $Y$  represents the spectrum of possible desires that would result. Furthermore, I will assume that the  $n$ -dimensional domain of the input vector  $\mathbf{X}$  can be mapped to a scalar quantity  $X^*$  which in keeping with the normal domain (or  $X$  axis) of a sigmoid function can now range from  $-\infty$  to  $+\infty$ . Theoretically, such a mapping could be accomplished by a separate neural network that is trained to map the input vector  $\mathbf{X}$  to  $X^*$ , where  $X^*$  is now constrained so as to produce a monotonically increasing function as  $X^*$  varies from  $-\infty$  to  $+\infty$  (i.e. Figure 13). Theoretically, I could also normalize limits of the domain between 0 and 1, but to be consistent with the normal domain of the sigmoid function, I consider an infinite domain. Consistent with the typical sigmoid function range, I will assume that the desires associated with  $Y$  can be normalized between 0 and 1, where for the purposes of our example I hypothesize all desires between 0 and 0.5 as negative or sinful desires and all desires between 0.5 and 1.0 as positive or righteous desires. Alternative formulations are obviously possible. For example, one could adopt an approach where a  $Y$  value associated with 0.5 could be considered righteous, while extremes in either direction would be sinful, however in order to be consistent with the normal range of a sigmoid function, I adopted the former convention.

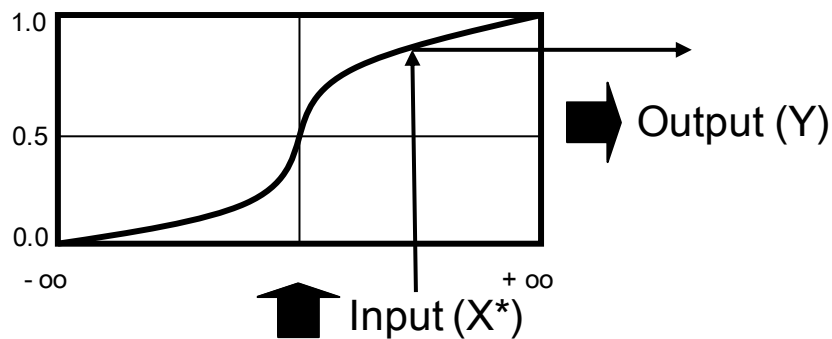

**Figure 13. Representation of the ANN as a single Sigmoid Function**

### ***Application to a Compatibilist Perspective of Free Will***

Use of such a simplification provides a conceptual framework by which to better understand a compatibilist perspective of free will. In this case, the sigmoid function in effect represents the “heart function” of a particular individual. One could argue that when people exercise their “free” wills, they are in fact operating consistent with their internal heart function (as obviously influenced by a multiplicity of factors). In the same way that an output from an artificial neural network may seem mysterious and free from the influence of the causative input vector (i.e. the ANN may appear to be simply a black box), we know that in this case, it is obviously causatively determined by the structure

and weights of the associated ANN. Thus it may be that when a person exercises their compatibilist free will, what seems to be a totally libertarian free action on their part may in fact be causatively determined by factors that are filtered and controlled by their own deterministic heart function. While one may argue that the structure and weights of the network may in fact change over time in response to life experiences, etc., perhaps through a type of spiritual epigenetics, a compatibilist interpretation implies that the initial heart function is in fact set at birth in much the same way that the genetic makeup of an individual is predetermined.

**Soteriology Application from a Calvinist Perspective**

Use of a composite sigmoid function as model for the human heart provides both a conceptual and graphical framework from which to visualize the soteriology of the traditional Calvinism (see Figure 14). I will now expand the composite response function to include the entirety of the soul, which would encompass the deliberations of the mind and the action of the will.

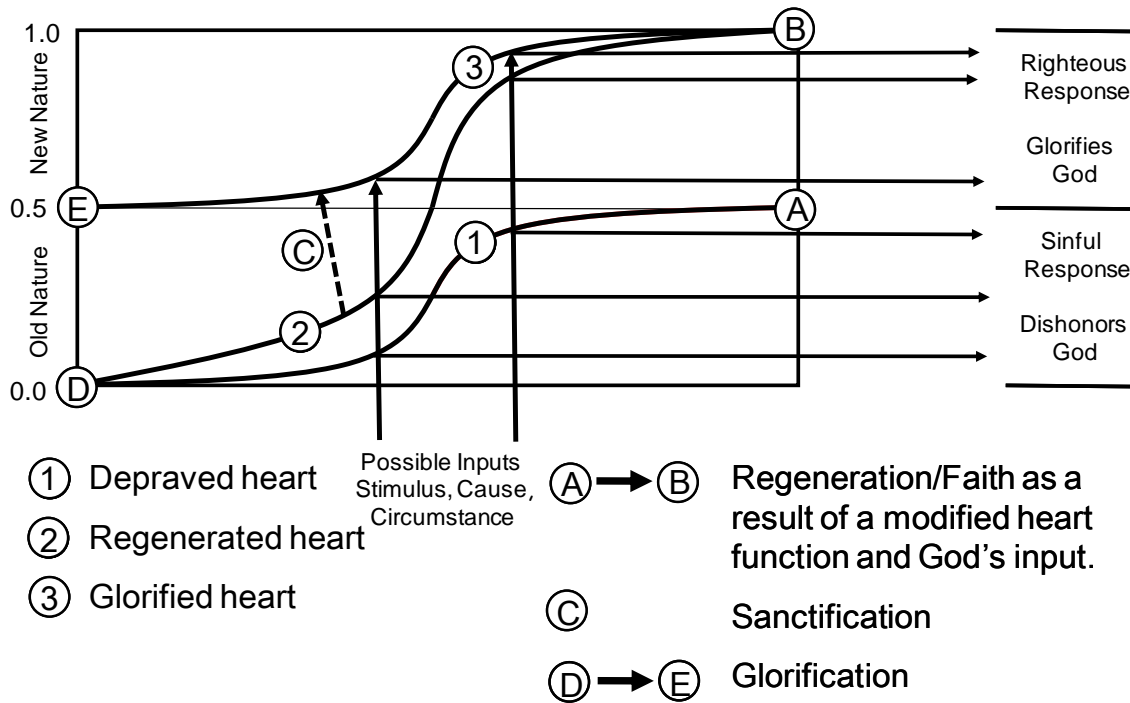

**Figure 14. Illustration of Calvinistic Soteriology Employing Free Knowledge**

In this case, I have divided the range of the sigmoid function into two regions: a region from 0 to .5 that represents the region of the old nature and a region from 0.5 to 1 that represents the region of the new nature. This model assumes that everyone is born with a depraved heart (Romans 3:10-11). This may now be visualized as a sigmoid function with a range constrained between 0 and 0.5, as illustrated with function (1) in Figure 14. Thus, I envision all individuals to be born with a bound or barrier of responsiveness as illustrated by the horizontal line connecting points E and A. In this

case, one could visualize the biblical Fall as the drop or fall of the response function from above to below this line. Mathematically, this means that whatever the domain of possible stimuli, the individual will always respond with a depraved desire that results in a sinful response. One may visualize regeneration in this model as the event in which the far right boundary of the function (1) (i.e. point A) is now shifted to point B thereby producing function (2). This soul function is now capable of generating either a sinful response or a righteous response. Furthermore, one can now visualize sanctification as the process whereby soul function (2) is shifted upward over time so that more of the range is in the upper region than in the lower region. Finally, at the moment of glorification, the lower left boundary of the function (2) (i.e. point D) now shifts up to point E, resulting in a soul function (3) that is now totally contained within the upper domain so that any response will be a righteous one.

The question remains, however, as to how the process of regeneration actually occurs. Using a Calvinist perspective it would seem that at least two possibilities exist. In the case in which middle knowledge is not employed (i.e. God's knowledge of the elect is based on free knowledge), God explicitly intervenes into the response function of the individual and moves the boundary of the function from point A to point B (see Figure 14) (e.g. Ezekiel 36:26).

In the case in which middle knowledge is employed, God provides those set of effectual graces to the individual, which results in a faith response that is credited as saving faith. I present two hypotheses for the latter case. Perhaps God intervenes at the boundary of the response function by providing a stimulus that results in a saving response (e.g. 0.5). Or perhaps everyone is born with a response function that possess a responsive zone that is not accessible unless God moves a vertical boundary of responsiveness by an act of effectual grace (see Figure 15) thereby allowing the person to respond positively to the gospel. In this case, such a movement could be complete (i.e. instantaneously moving the boundary from point A to point B) or incremental (slowly moving the boundary from point A to point B). In the latter case, one could then visualize the process of sanctification as being two dimensional, both vertically (as in Figure 14) and horizontally (as in Figure 15).

## **7. Conceptualization of Indeterminism Using an ANN**

In the same way that we can use an ANN to conceptualize the response of a free agent assuming a compatibilist free will, we can use the same model to conceptualize the response of a free agent assuming a libertarian free will. In this case, the output is not a dominant desire, but an associated free choice influenced by the structure and weights of the ANN, which we now use to conceptualize the influence (though not control) of the will by the heart (and mind). However, if one uses the standard structure as illustrated in Figure 12 (where the word "desire" is now replaced with the word "choice"), one may be argue that the result from such a model is in fact not really free, but is in fact causally determined as with the dominant desire from the compatibilist model. One way to circumvent that limitation is to employ a feature that is typically used in most actual ANN applications. This feature involves the addition of a "bias" node to the network,

which provides an additional input that is independent of any of the normal model inputs. For the purposes of this illustration, I will call this node the “free or libertarian node” (see Figure 16).

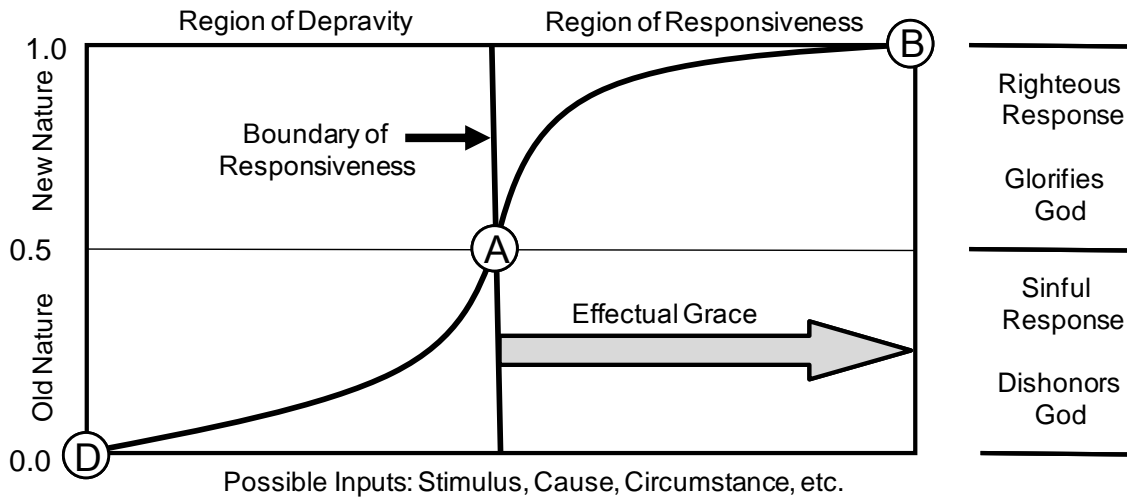

**Figure 15. Illustration of Calvinistic Soteriology Employing Middle Knowledge**

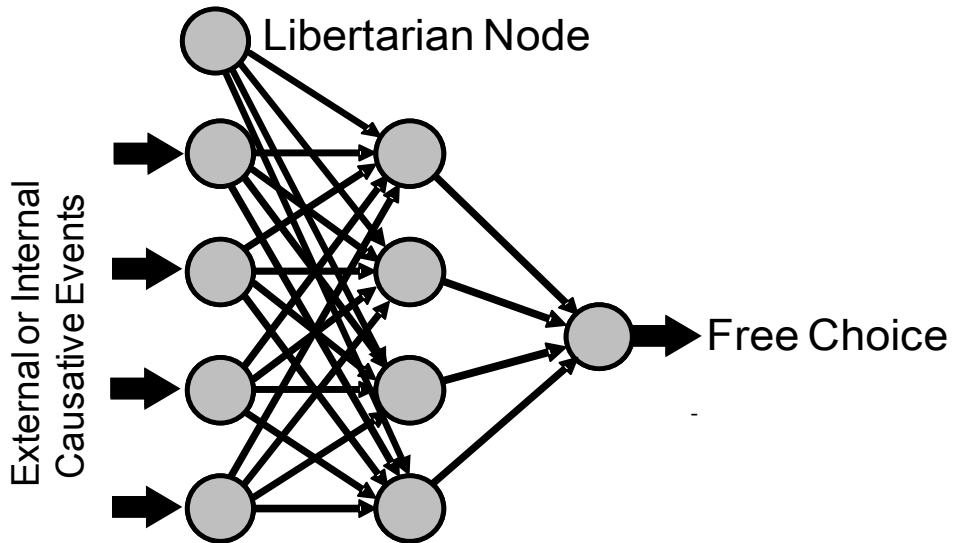
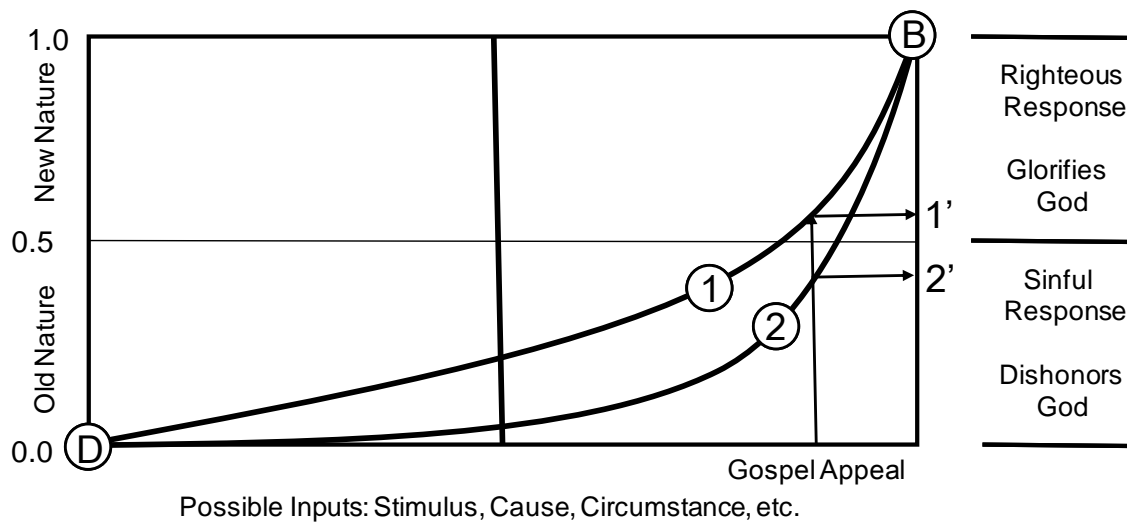

**Figure 16. Conceptualization of the Libertarian Free Will as an ANN**

In this model, the impacts of the causative inputs and weights of the network certainly influence the free choice, but the libertarian node still has the properties and potential to provide an input to the network that can lead to a choice contrary to the normal dominant desire response that might result.

Once again, as with the model of the heart, one may also construct a simplified model of the will using a single sigmoid function. As with the heart, the term “will” may be now expanded to include the entirety of the soul, which again would encompass the

influence of the mind and the heart. Likewise, one may derive an associated visualization of Arminian soteriology. In the latter case, one might argue that while all response functions have been initially constrained so as to yield responses with a range from 0 to 0.5 (i.e. sinful responses), God provides a prevenient grace to all functions that shifts their boundary to point B (see Figure 17). Still, the inherent nature of some individuals make them more responsive to a range of inputs than others. For example, we may envision two different individuals 1 and 2 with separate response functions as shown in Figure 17. In this case, the same input stimulus results in two different responses (1' and 2'), where the 1' response results in saving faith (i.e.  $Y > .5$ ) and the 2' response results in a response lacking in faith (i.e.  $Y < .5$ ) (e.g. Genesis 4:2-7). Secondly, we can envision that while all response functions possess some region in which they may respond positively to the gospel, the nature of most functions is so elliptically shifted to the right (e.g. Figure 17) that during a lifetime of various gospel stimuli they continue to respond in a negative fashion. In this case, the culpability lies not with God, who has provided a prevenient grace as well as subsequent revelation, but a response function that is so bent and distorted that it will not respond in a positive fashion (e.g. Exodus 8:19). Of course, one may argue that after a continued pattern of disobedience God at some point may pronounce judgment on a individual while they are still living by fixing their response function in its depraved state (e.g. I Samuel 2:22-25).



**Figure 17. An Illustration of Arminian Regeneration**

If one assumes that the shape of the response function is under the sole influence of the individual (i.e. the libertarian node can influence not only the response but perhaps the weights of the network itself), then, ultimately, each person has the freedom to respond in a positive way to a gospel initiative. That is, they are responsible for whether or not they exert their wills sufficiently to move their response function into a position to where it may respond positively. From a traditional Arminian perspective, God then possesses the natural knowledge of the shape of the response function throughout the life of the individual and thus knows which individual will ultimately respond to the gospel and which individual ultimately will not. This then forms the basis of their election. From



a middle knowledge perspective, God knows how each individual will respond to the lifetime of graces that are extended to them. In choosing to create an individual who he knows will respond positively to those graces, God then effectively elects that individual. In either case, the process of sanctification can again be envisioned as a migration or shift of the response function upward over time.

## 8. The Origin of the Response Function

In proposing the concept of a human response function, the obvious question arises of how such a function might originate. This is equivalent to the question, “what is the origin of the human soul?” I propose two initial possibilities. One possibility is that the response function comes into existence at the same time as physical life and results from the combination of the response functions of the parents (similar to their physical DNA). The possibility of such a model or at least the possibility that the “spiritual epigenetics” of a parent might be passed to their offspring could be implied by Exodus 20:5. Such a theory could have further implications with regard to the continued inheritance of our sin nature from Adam as well. Perhaps, as we are now discovering with biological epigenetics, the problem may not be exclusively with our spiritual DNA, but with “spiritual genes” that have been turned on or off as a result of our parents spiritual response or even our own. By way of analogy, perhaps we are all born with or further degrade our own broken neural networks, whose weights or links can only be repaired through the spiritual process of sanctification and the renewal of our physical neural network (i.e. Romans 12:1-3) following the process of regeneration. Additional speculations are left to the reader.

Another possibility for the origin of the response function is that God assigns a unique function to each individual when they are born (see Psalm 33:13-15), drawing from an infinite set of possible response functions that may follow a particular probability density (e.g. normal probability distribution). In this case, one might hypothesize that the assignment is done explicitly by divine fiat or implicitly, perhaps through some type of spiritual Monte Carlo simulation. For example, Bradley<sup>22</sup> has recently proposed how God could use randomness to accomplish his purposes. This could represent one possible application; however, to paraphrase Einstein, it is likely that some would argue, “God does not play dice with the *spiritual* universe *either*.” Regardless of the method, the fact that God seems to be operational in the creation of each person is certainly implied in Acts 17:24-28.

## 9. A Possible Synthesis

I have proposed an artificial neural network for use as a conceptual model of human behavior. I have proposed two different models (i.e. Figures 12 and 16) for use in describing the operation of compatibilist and libertarian free will in the context of Christian soteriology (i.e. Arminianism and Calvinism). Generally, theologians view these two positions as mutually exclusive. However, what if compatibilist free will is actually a subset of libertarian free will? Drawing on Figure 16, what if in many cases the influence of the libertarian node is insufficient to counteract the influences of the other

inputs, and thus the libertarian will is overpowered by the desires originating from the heart (e.g. Romans 7:15-20)? In the latter case, one would then observe an individual operating as if he or she possessed a compatibilist free will. Such an observation would then be consistent with those biblical passages that tend to imply the existence of a compatibilist free will. However, in other instances, perhaps the libertarian node is able to exert sufficient influence to overpower the dominant desire of the heart. Such an observation would then be consistent with those biblical passages that tend to imply the existence of a libertarian free will. This obviously raises additional questions. For example, how is God able to know the actions of such an agent under both circumstances? Perhaps middle knowledge is used to know both the heart and the will as well as what component will yield the dominant influence in each situation. Given such knowledge, God could again control the set of causative events that would then yield a known result. Additional implications remain. The point here is not to necessarily advocate for a specific hypothesis, but to present one example of how the proposed models might be subsequently employed in the development of such hypotheses. Additional applications are left to the reader.

## 10. Summary and Conclusions

I have presented a mathematical framework for obtaining a better understanding of the philosophical and theological implications of the nature of human free will. With humble recognition of the obvious limitations of humankind, as acknowledged in Romans 11:33, I hope that the proposed framework may provide some new insights into how to better understand and explain the diversity of existing perspectives as well as potentially lead to new syntheses of ideas that may provide a clearer picture of the operation of the gospel itself over the life of an individual. I envision such a goal to have both potential theological and evangelical applications and benefits.

## 11. References

<sup>1</sup>Eric Berne, *Games People Play – The Basic Hand Book of Transactional Analysis*, (New York: Ballantine Books, 1964).

<sup>2</sup>George E. P. Box; Norman R. Draper, *Empirical Model-Building and Response Surfaces*, (New York: Wiley, 1987), 424.

<sup>3</sup>J. P. Moreland and William L. Craig, *Philosophical Foundations for a Christian Worldview*, (Downers Grove, Illinois: Intervarsity Press, 2003), 240.

<sup>4</sup>Bruce Ware, *God's Greater Glory*, (Wheaton, IL: Crossway Books, 2004), 110-130.

<sup>5</sup>JGeisler, N., *Chosen But Free*, (Minneapolis, Minnesota, Bethany House Publishers, 1999), 28.

<sup>6</sup>J. P. Moreland and William L. Craig, *Philosophical Foundations for a Christian Worldview*, (Downers Grove, Illinois: Intervarsity Press, 2003), 517-534.

- <sup>7</sup>Bruce Hasker, *Metaphysics*, (Downers Grove, Illinois: Intervarsity Press, 1983), 32.
- <sup>8</sup>Gregory Boyd and Paul Eddy, *Across the Spectrum*, (Grand Rapids, Michigan: Baker Academic, 2002), 143-144.
- <sup>9</sup>William L. Craig, "Middle Knowledge: A Calvinist-Arminian Rapprochement", *A Case for Arminianism: The Grace of God, the Will of Man*, Clark H. Pinnock, General Editor, (Grand Rapids, MI: Academic Books, 1989), 141-164.
- <sup>10</sup>Bruce Ware, *God's Greater Glory*, (Wheaton, IL: Crossway Books, 2004), 110-130.
- <sup>11</sup>William L. Craig "Middle Knowledge: A Calvinist-Arminian Rapprochement", *The Grace of God, the Will of Man*, Clark H. Pinnock, General Editor, (Grand Rapids, MI: Academic Books, 1989), 157.
- <sup>12</sup>J. P. Moreland and William L. Craig, *Philosophical Foundations for a Christian Worldview*, (Downers Grove, Illinois: Intervarsity Press, 2003), 522.
- <sup>13</sup>Richard Rice, *The Openness of God: The Relationship of Divine Foreknowledge and Human Free Will*, (Review and Herald Pub. Association 1980).
- <sup>14</sup>John Sanders, *The God Who Risks: A Theology of Providence*, (Downers Grove, IL: InterVarsity Press, 1998).
- <sup>15</sup>Gregory A Boyd, *God of the Possible: A Biblical Introduction to the Open View of God*, (Grand Rapids, MI: Baker, 2000).
- <sup>16</sup>Clark H. Pinnock, *Most Moved Mover: A Theology of God's Openness*, (Grand Rapids, Michigan: Baker Academic, 2001).
- <sup>17</sup>Clark Pinnock, *The Grace of God, the Will of Man*, (Grand Rapids, Academic Books, 1989), 25.
- <sup>18</sup>Bruce Ware, *God's Greater Glory*, (Wheaton, IL: Crossway Books, 2004), 110-130.
- <sup>19</sup>Alfred J. Freddoso, *On creation, conservation, and concurrence. Metaphysical Disputations 20, 21, and 22 by Francisco Suarez*, (South Bend, IN: St. Augustine Press, 2002).
- <sup>20</sup>Russell Beale and T Jackson, *Neural Computing – An Introduction* (Philadelphia, PA: Institute of Physics, 1990).
- <sup>21</sup>Kevin Gurney, *An Introduction to Neural Networks*, (Boca Raton, FL: CRC Press, 1997).

<sup>22</sup>James Bradley “Randomness and God’s Nature,” *Perspectives on Science and Christian Faith*, Vol. 64, No. 2, (2012), 75-89.